

Rivenditore

**Riferimento Codice NOMENCLATORE TARIFFARIO**

Carrozzina a telaio fisso superleggera 12.21.06.060

**Nr. Repertorio DM: 64227/R**

**Legenda**

- di serie      ○ accessori con maggiorazione  
 accessori a N.T.      ☆ accessori a listino  
 accessori a N.T. con maggiorazione

## FENICE

- L** Larghezza Sedile     34    36    38    40    42    44  
**P** Profondità Sedile     36    38    40    42    44  
**HS** Altezza Schienale     27    29    31    33    35    37    39  
**HA** Altezza Sedile Anteriore     46    48    50  
**HP** Altezza Sedile Posteriore     40    42    44    46  
**DP** Distanza Sedile Pedana     35    37    39    41    43    45    47    49

cm

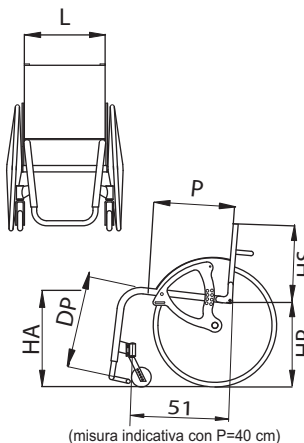

**Colore telaio**

- Grigio metallizzato     Bianco perlato     Azzurro metallizzato  
 Nero brillante     Viola ciclamino  
 ..... (vedi catalogo "Colori")

①

**Rivestimento**

- Nylon tensionabile  
 Tessuto traspirante tensionabile  
 Senza telo schienale

②

**Pedana Unica Tubolare**

③

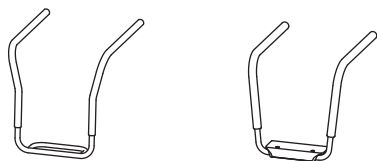

Aperta

Chiusa in carbonio

**Maniglie di spinta per accompagnatore**

④

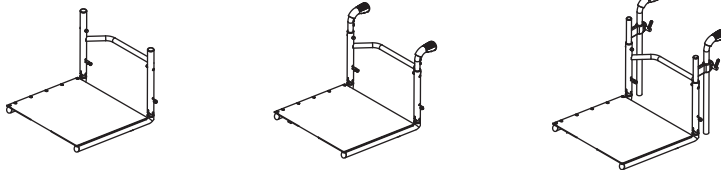

Senza maniglie

Maniglie fisse

Maniglie regolabili in altezza

**Distanza tra centro mozzo e schienale**

⑤

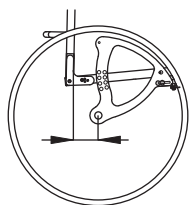

- 7 cm     13 cm  
 9 cm (standard)     15 cm  
 11 cm

**Inclinazione schienale regolabile**

⑥

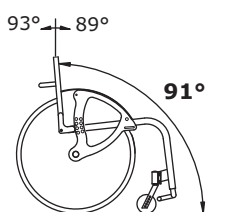

- 89°  
 91° (standard)  
 93°

**Angolo anteriore**

⑦

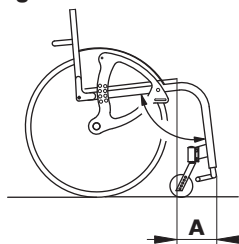

- 92° (standard) (A = 16 cm)  
 97° (A = 22 cm)  
 (misure indicative per un assetto standard)

**Campanatura ruote posteriori**

⑧

- 1°     2°  
 3°     4°

**Salva abiti**

⑨



in fibra di carbonio

alluminio

**Freni**

⑩

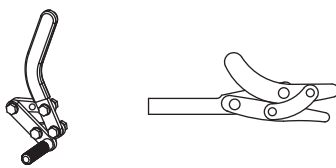

Standard

a Scomparsa

**Antiribaltamento girevole**

⑪

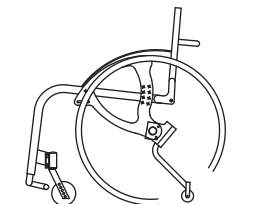

☆ Destro

☆ Sinistro

Note

Rivenditore

<p><b>Ruote posteriori</b> (12)</p> <input type="checkbox"/> 24" Light (24 raggi) <input type="checkbox"/> 24" Star 6x3 (18 raggi) <input type="checkbox"/> 24" (36 raggi) <input type="checkbox"/> 24" Mountain-bike <input type="checkbox"/> 24" Ultralight (24 raggi) <input type="radio"/> 24" Spinergy <input type="radio"/> 24" Jet 12	<p><b>Corrimano</b> (13)</p> <input type="checkbox"/> Alluminio chiaro <input type="checkbox"/> Alluminio scuro <input type="checkbox"/> Acciaio cromato <input type="radio"/> Titanio <input type="radio"/> Gommato (a fusione) <input type="radio"/> Tween Greep <input type="radio"/> Max Grepp <input type="radio"/> Max Grepp Ergo (**) <input type="checkbox"/> Copricorr. in silicone	<p><b>Copriraggi</b> (14)</p> <input type="checkbox"/> Trasparenti <input type="checkbox"/> Bianchi <input type="checkbox"/> Neri <input type="checkbox"/> Multicolor <input type="checkbox"/> Neri piumati rosso <input type="checkbox"/> Neri piumati blu <input type="checkbox"/> Neri piumati verde <input type="checkbox"/> Alfabeto	<p><b>Ruotine anteriori</b> (15)</p> <input type="checkbox"/> 80 (3") piene L 25 mm <input type="radio"/> 80 (3") piene con luci L 25 mm <input type="checkbox"/> 100 (4"x1.1/4) piene cerchio plastica <input type="radio"/> 100 (4"x1) piene con luci <input type="checkbox"/> 100 (4"x1) piene cerchio all. L 25 mm <input type="checkbox"/> 100 (4"x1.1/4) piene cerchio all. L 32 mm <input type="checkbox"/> 125 (5"x1.1/4) piene cerchio plastica <input type="checkbox"/> 125 (5"x1) piene cerchio all. L 25 mm <input type="checkbox"/> 125 (5"x1.1/4) piene cerchio all. L 32 mm <input type="checkbox"/> 150 (6") pneumatiche <input type="checkbox"/> 150 (6") piene
--	--	--	--

(\*\*) non disponibili con ruote Star 6x3 e Mountain bike

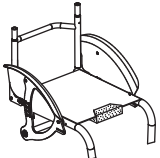
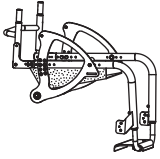
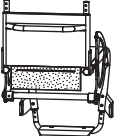
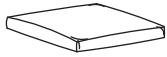
<p><b>Tasche</b> (16)</p>  <input type="checkbox"/> Tasca sedile  <input type="checkbox"/> Porta oggetti  <input type="checkbox"/> Tasca schienale	<p><b>Cuscino foderato in poliuretano espanso</b> (17)</p>  <input type="checkbox"/> Altezza 3 cm <input type="checkbox"/> Altezza 5 cm	<p><b>Opzioni</b></p> <p>19 <input type="checkbox"/> Velcro "M" (uncino) sul sedile      20 <input type="checkbox"/> Velcro "F" (asola) sul sedile      21 <input type="checkbox"/> Sedile rigido imbottito h 5      22 <input type="checkbox"/> Bretellaggio      23 <input type="checkbox"/> Cintura pettorale      24 <input type="checkbox"/> Divaricatore a fasce      25 <input type="radio"/> Tasca portacatetere      26 <input type="checkbox"/> Dx <input type="checkbox"/> Sx Portastampella      27 <input type="checkbox"/> Pompetta per pneumatici      28 <input type="checkbox"/> Set portavaligia      29 <input type="checkbox"/> Cintura pelvica a 45°      30 <input type="checkbox"/> Cintura pelvica imb. a 45°      31 <input type="checkbox"/> Zainetto nero      33 <input type="checkbox"/> Portaombrello      34 <input type="checkbox"/> Protezioni anteriori</p>
<p><b>Set anodizzato</b> (18)  <i>(Cerchi ruote post., mozzi e forcelle)</i></p> <input type="checkbox"/> Nero <input type="checkbox"/> Argento <input type="radio"/> Verde <input type="radio"/> Azzurro <input type="radio"/> Rosso <input type="radio"/> Arancio <input type="radio"/> Viola ciclamino <p>(Solo ruote Light)</p>		

Note

---

---

---

---

---

---

---

---

---

---